

IRRIGATION RISER MANIFOLD

ANOTHER INTELLIGENT IRRIGATION SOLUTION



NEW



RAIN PRO[®]

Intelligent Irrigation Solutions™





SINGLE BALL VALVE

RVMHT

- High Flow Ball Valve with a 3/4" Female Swivel x 3/4" Male Hose Thread or 500, 600, 700**



SINGLE OUTLET ELBOW

RVELHMT

- 3/4" Deep Socket Inlet / 1" Spigot
- High Flow Ball Valve
- Choice of 500, 600, 700** or 3/4" Male Hose Thread Connection



2 OUTLET TEE

RVTMHT

- 3/4" Deep Socket Inlet / 1" Spigot
- 2 Outlets with 2 High Flow Ball Valves
- Choice of 500, 600, 700** or 3/4" Male Hose Thread Connection



4 OUTLET

RV4MHT-V

"Dual Line Drip Special"

- 3/4" Deep Socket Inlet / 1" Spigot
- 4 Outlets with 4 High Flow Ball Valves
- Choice of 500, 600, 700** or 3/4" Male Hose Thread Connection
- Shown with Optional Ball Valve for Flushing



6 OUTLET

RV6MHT-V

"Dual Line Drip + Sprinkler Line Special"

- 3/4" Deep Socket Inlet / 1" Spigot
- 6 Outlets with 6 High Flow Ball Valves
- Choice of 500, 600, 700** or 3/4" Male Hose Thread Connections
- Shown with; Optional Ball Valve for Flushing

**Special Order Multiple Outlet Size Mix+Match



FEATURES

- One complete manifold of 6, 4, 2 or 1 outlet
- Dedicated High Flow Ball Valve per outlet
- High Flow Ball Valves are field service-able
- Manifold Inlet is a 3/4" Socket / 1" Spigot
- Easy start-up flush without contamination
- Low Profile Installation
- Low Profile Handles

**Outlet Choices:

- 500 ID / 16mm/17mm (.510"-.580") with Double Thread
- 600 ID / 18mm (.590"-.630") with Double Thread
- 700 ID / 20mm (.685"-.740") with Double Thread
- 3/4" Male Hose Thread Outlet

**Special Order Multiple Outlet Size Mix+Match

BENEFITS

- Manifolds are pre-assembled requiring No Field Assembly
- Total control of each individual output
- High Flow Valve with low pressure loss = energy savings
- Easy replacement with Repair Coupling



RVRC

Deep Socket Inlet Repair Coupler
1" Socket x 3/4" Socket / 1" Spigot



High Flow Ball Valve

EXAMPLE OF OUTLET CHOICES

Available Options:

500 ID (16mm/17mm)

600 ID (18mm)

700 ID (20mm)

Hose Cap Standard, Optional Ball Valve Swivel with 3/4" Male Hose Thread

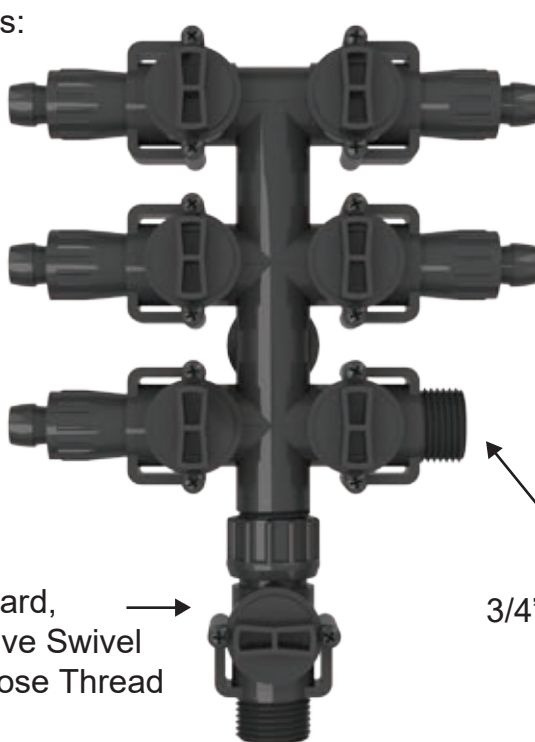

500 ID (16mm/17mm)

600 ID (18mm)

3/4" Hose Thread

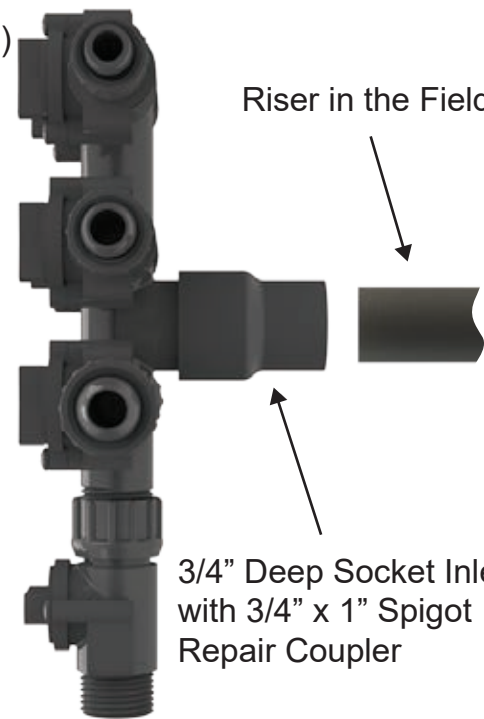

Riser in the Field

3/4" Deep Socket Inlet with 3/4" x 1" Spigot Repair Coupler

6 Outlet with Optional Ball Valve For Flushing



ORDERING INFORMATION

Model #	Description
RVMHT	FHT SWIVEL x MHT HIGH FLOW BALL VALVE
RVELMHT	3/4 SOC/1 SPIG ELL x MHT HIGH FLOW BALL VALVE
RVEL5	3/4 SOC/1 SPIG ELL x .500 BARB LOC HIGH FLOW BALL VALVE
RVEL6	3/4 SOC/1 SPIG ELL x .600 BARB LOC HIGH FLOW BALL VALVE
RVEL7	3/4 SOC/1 SPIG ELL x .700 BARB LOC HIGH FLOW BALL VALVE
RVTMHT	3/4 SOC/1 SPIG TEE x MHT HIGH FLOW BALL VALVE MANIFOLD
RVT5	3/4 SOC/1 SPIG TEE x .500 BARB LOC HIGH FLOW DUAL BALL VALVE
RVT6	3/4 SOC/1 SPIG TEE x .600 BARB LOC HIGH FLOW DUAL BALL VALVE
RVT7	3/4 SOC/1 SPIG TEE x .700 BARB LOC HIGH FLOW DUAL BALL VALVE
RV4MHT-C	3/4 SOC/1 SPIG 4 OUTLET x MHT HIGH FLOW BALL VALVE MANIFOLD w/ CAP
RVT45-C	3/4 SOC/1 SPIG 4 OUTLET x .500 BARB LOC HIGH FLOW BALL VALVE MANIFOLD w/ CAP
RVT46-C	3/4 SOC/1 SPIG 4 OUTLET x .600 BARB LOC HIGH FLOW BALL VALVE MANIFOLD w/ CAP
RVT47-C	3/4 SOC/1 SPIG 4 OUTLET x .700 BARB LOC HIGH FLOW BALL VALVE MANIFOLD w/ CAP
RV6MHT-C	3/4 SOC/1 SPIG 6 OUTLET x MHT HIGH FLOW BALL VALVE MANIFOLD w/ CAP
RVT65-C	3/4 SOC/1 SPIG 6 OUTLET x .500 BARB LOC HIGH FLOW BALL VALVE MANIFOLD w/ CAP
RVT66-C	3/4 SOC/1 SPIG 6 OUTLET x .600 BARB LOC HIGH FLOW BALL VALVE MANIFOLD w/ CAP
RVT67-C	3/4 SOC/1 SPIG 6 OUTLET x .700 BARB LOC HIGH FLOW BALL VALVE MANIFOLD w/ CAP
RVRC	3/4 x 1 SOC/SPIG x 1 SOC REPAIR COUPLER

FOR THE BEST IN MEDIA FILTRATION CHECK OUT THE WATER TOOL 12" AND 24"



12" AT 15-25 GPM PER TANK



24" AT 40-100 GPM PER TANK



HIT Products Corporation
P.O. Box 929
556 S. Mirage Avenue
Lindsay, CA. USA 93247
Phone: (559) 562-5975 or (800) 468-0071
Fax: (559) 562-6626
Email: sales@hitproductscorp.com
5.23.2017





ADVANTAGES OF THE IRRIGATION RISER MANIFOLD

ANOTHER INTELLIGENT IRRIGATION SOLUTION BY RAINPRO



- Ease and Cost of Installation – No Field Labor assembling manifolds
- Lowest manifold pressure loss – Save on Pumping Costs
- One SKU – same at every lateral
- Low Profile Design – Minimize valve damage in field
- High Flow Valve for each individual line –
Individual line control and very low pressure loss
- 100% Serviceable in field – No problem if damaged
- No leaky Hose Swivel Washers – No Dripping Fittings, No field repair required

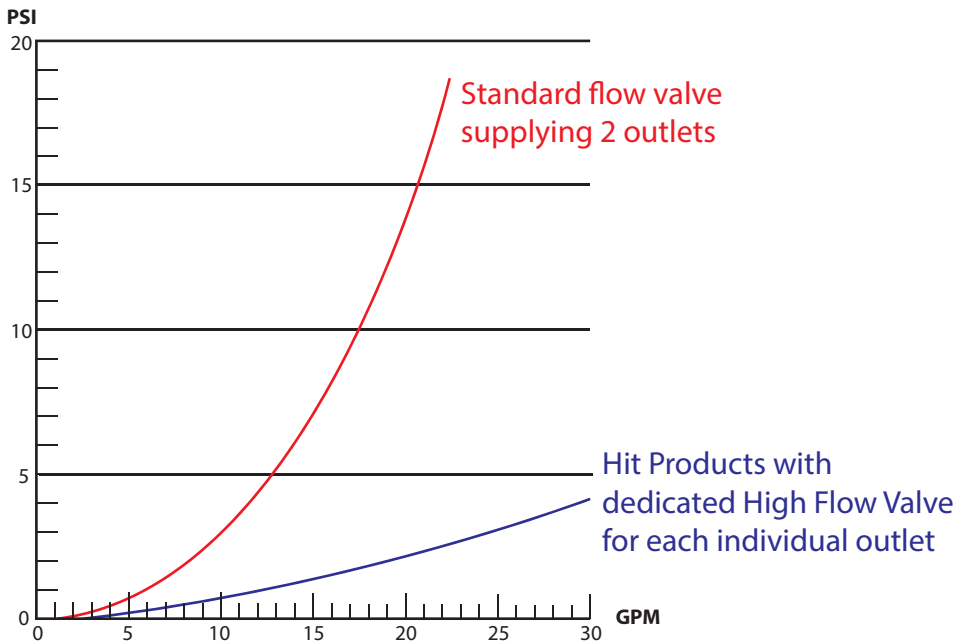



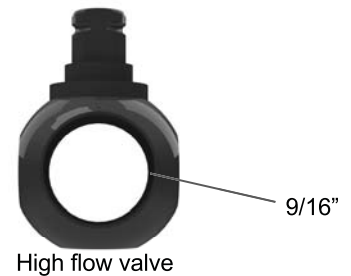



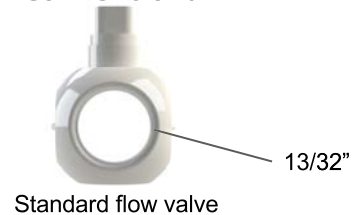

Hit Products



Conventional



IRRIGATION RISER MANIFOLD PRICE LIST

	List Price	Part Number	Description	Bag Qty	Case Qty			
	\$3.75	RVMHT	MHT High Flow Valve w/ Lateral Connections FHT SWIVEL x MHT HIGH FLOW BALL VALVE FHT SWIVEL x .500 HIGH FLOW BALL VALVE FHT SWIVEL x .600 HIGH FLOW BALL VALVE FHT SWIVEL x .700 HIGH FLOW BALL VALVE	10	50			
	\$4.00	RV5 RV6 RV7						
	\$3.75	RVELMHT				1 Outlet w/ Ell 3/4SOC/1 SPIG ELL x MHT HIGH FLOW DUAL BALL VALVE 3/4SOC/1 SPIG ELL x .500 BARB LOC HF BALL VALVE 3/4SOC/1 SPIG ELL x .600 BARB LOC HF BALL VALVE 3/4SOC/1 SPIG ELL x .700 BARB LOC HF BALL VALVE	10	50
	\$4.65	RVEL5 RVEL6 RVEL7						
	\$6.45	RVMHT	2 Outlet Tee 3/4SOC/1 SPIG TEE x MHT HIGH FLOW DUAL BALL VALVE 3/4SOC/1 SPIG TEE x .500 BARB LOC HF BALL VALVE 3/4SOC/1 SPIG TEE x .600 BARB LOC HF BALL VALVE 3/4SOC/1 SPIG TEE x .700 BARB LOC HF BALL VALVE	10	50			
	\$6.90	RVT5 RVT6 RVT7						
	\$14.50	RV4MHT-C				4 Outlet w/ Flush Cap 3/4SOC/1 SPIG 4 x MHT HIGH FLOW DUAL BALL VALVE w/ CAP 3/4SOC/1 SPIG 4 x .500 BARB LOC HF BALL VALVE w/ CAP 3/4SOC/1 SPIG 4 x .600 BARB LOC HF BALL VALVE w/ CAP 3/4SOC/1 SPIG 4 x .700 BARB LOC HF BALL VALVE w/ CAP	10	50
	\$15.50	RV45-C RV46-C RV47-C						
	\$16.90	RV4MHT-V	4 Outlet w/ Flush Valve 3/4SOC/1 SPIG 4 x MHT HIGH FLOW DUAL BALL VALVE 3/4SOC/1 SPIG 4 x .500 BARB LOC HF BALL VALVE 3/4SOC/1 SPIG 4 x .600 BARB LOC HF BALL VALVE 3/4SOC/1 SPIG 4 x .700 BARB LOC HF BALL VALVE	10	50			
	\$17.95	RV45-V RV46-V RV47-V						
	\$19.90	RV6MHT-C				6 Outlet w/ Flush Cap 3/4SOC/1 SPIG 6 x MHT HIGH FLOW DUAL BALL VALVE w/ CAP 3/4SOC/1 SPIG 6 x .500 BARB LOC HF BALL VALVE w/ CAP 3/4SOC/1 SPIG 6 x .600 BARB LOC HF BALL VALVE w/ CAP 3/4SOC/1 SPIG 6 x .700 BARB LOC HF BALL VALVE w/ CAP	10	50
	\$20.95	RV65-C RV66-C RV67-C						
	\$22.45	RV6MHT-V	6 Outlet w/ Flush Valve 3/4SOC/1 SPIG 6 x MHT HIGH FLOW DUAL BALL VALVE 3/4SOC/1 SPIG 6 x .500 BARB LOC HF BALL VALVE 3/4SOC/1 SPIG 6 x .600 BARB LOC HF BALL VALVE 3/4SOC/1 SPIG 6 x .700 BARB LOC HF BALL VALVE	10	50			
	\$23.50	RV65-V RV66-V RV67-V						
	\$1.02	RVRC				Repair Coupler 3/4 / 1" SOC/SPIG X 1" SOC REPAIR COUPLER	10	50

Effective May 23, 2017

